



Fahrgestell-Nr.: F

Auftrags-Nr.: AU-

Projekt-Nr.: PR-

Kunde: ---

Dateiname: Solo-Rondomat\_600\_2019-03-25

Letzt. Änderung: 25.03.2019 13:03

Letzter Druck: 25.03.2019 13:03

\$HeadURL: svn://flsv-eni2/ENI3/Allgemeines/Elektro-Schaltplan/lbr/Fliegl/e-elektro-zeichnungsrahmen\_FlieglLogo.lbr \$

\$LastChangedBy: zaffral \$

\$LastChangedDate: 2019-03-22 09:57:59 +0100 (Fr, 22 Mrz 2019) \$

\$LastChangedRevision: 15298 \$

\$Id: e-elektro-zeichnungsrahmen\_FlieglLogo.lbr 15298 2019-03-22 08:57:59Z zaffral \$

### Solo-Rondomat

Dateiname: Solo-Rondomat\_600\_2019-03-25

Auftrags-Nr.: AU-

Projekt-Nr.: PR-

Artikel-Nr.: 517063

Serien-Nr.:

Solo-Rondomat

Best.Var:  
PCB-Artikelnr.: 000000

Blatt 1 von 21

Katalog-Nr.:



Kunde:

---

Datum 18.03.2019

Bearb. zaffral

Gepr.

Norm

Änderung	Datum	Name	Norm
1			

1

2

3

4

5

6

7

	1	2	3	4	5	6	7																														
A	Seite 001: Solo-Rondomat																																				
	Seite 002: Inhaltsverzeichnis																																				
	Seite 003: Kabelfarben																																				
	Seite 004: Motorenübersicht																																				
B	Seite 005: Einspeisung / Schrankheizung																																				
	Seite 006: Spannungsverteilung 24V																																				
	Seite 007: Motoren																																				
	Seite 008: Sicherheitsrelais																																				
	Seite 009: Steuerausgänge (Output)																																				
	Seite 010: Störungen (Input)																																				
C	Seite 011: Analog Strommessung / 4-20mA																																				
	Seite 012: Analog Strommessung / 4-20mA/Reserve																																				
	Seite 013: Externe Signale (Output)																																				
	Seite 014: Externe Eingänge (Input)																																				
D	Seite 015: CAN-BUS / Ext. Display / Funk																																				
	Seite 016: Touchpanel																																				
	Seite 017: Mechanikteile																																				
	Seite 018: Mechanikteile																																				
	Seite 019: Stückliste																																				
E	Seite 020: Stückliste																																				
	Seite 021: Stückliste																																				
F																																					
G																																					
H						<b>Inhaltsverzeichnis</b> Dateiname: Solo-Rondomat_600_2019-03-25 Auftrags-Nr.: AU- Projekt-Nr.: PR- Artikel-Nr.: 517063 Serien-Nr.:																															
				<b>Fliegl</b> Kunde: ---		<b>Solo-Rondomat</b> Best.Var: PCB-Artikelnr.: 000000																															
	<table border="1"> <thead> <tr> <th>Änderung</th> <th>Datum</th> <th>Name</th> <th>Norm</th> </tr> </thead> <tbody> <tr> <td></td> <td>18.03.2019</td> <td>zaffral</td> <td></td> </tr> <tr> <td></td> <td></td> <td></td> <td></td> </tr> <tr> <td></td> <td></td> <td></td> <td></td> </tr> <tr> <td></td> <td></td> <td></td> <td></td> </tr> </tbody> </table>			Änderung	Datum	Name	Norm		18.03.2019	zaffral														<table border="1"> <tr> <td>Katalog-Nr.:</td> <td></td> </tr> <tr> <td>Datum Bearb.:</td> <td>18.03.2019 zaffral</td> </tr> <tr> <td>Gepr.:</td> <td></td> </tr> <tr> <td>---</td> <td></td> </tr> </table>		Katalog-Nr.:		Datum Bearb.:	18.03.2019 zaffral	Gepr.:		---		<table border="1"> <tr> <td>Blatt 2</td> <td>von 21</td> </tr> </table>		Blatt 2	von 21
Änderung	Datum	Name	Norm																																		
	18.03.2019	zaffral																																			
Katalog-Nr.:																																					
Datum Bearb.:	18.03.2019 zaffral																																				
Gepr.:																																					
---																																					
Blatt 2	von 21																																				
	1	2	3	4	5	6	7																														

	1	2	3	4	5	6	7
A							
B							
C							
D							
E							
F							
G							
H							

## Kabelfarben

Schwarz	Leistung 400V/230V
Rot	+24VDC Steuerspannung
Dunkelblau	GND 0VDC Steuerspannung
Orange	Optional
Hellblau	Neutralleiter
Grün/Gelb	Schutzleiter
Lila	Nothaltkreis +24V
Grün	Steuerkreis
Lila/weiss	Nothaltkreis GND

	Datum	18.03.2019	
	Bearb.	zaffral	
	Gepr.		
Änderung	Datum	Name	Norm

Katalog-Nr.:	
Kunde:	---



<b>Kabelfarben</b>	
Dateiname:	Solo-Rondomat_600_2019-03-25
Auftrags-Nr.:	AU-
Projekt-Nr.:	PR-
Artikel-Nr.:	517063
Serien-Nr.:	
<b>Solo-Rondomat</b>	
Best.Var:	PCB-Artikelnr.: 000000
Blatt 3 von 21	

	1	2	3	4	5	6	7
A							
B							
C							
D							
E							
F							
G							
H							

Motor	Funktion	Leistung	Strom	Ref. Seite
M1	Hydraulik/Mischer-Antrieb	11 kW	25 A	/7.2G
M2	Förderschnecke 3 / Trog	5,5 kW	11,5 A	/7.3G
M3	Förderschnecke 2 / Hochförd.	5,5 kW	11,5 A	/7.4G
M4	Förderschnecke 1 / Einbring.	3,6 kW	7,5 A	/7.5G
M5	Zusatzschnecke	3,6 kW	7,5 A	/7.6G
<b>Anschlussleistung</b>		<b>29.20 kW</b>	<b>63.00 A</b>	

Katalog-Nr.:



**Motorenübersicht**

Dateiname: Solo-Rondomat\_600\_2019-03-25

Auftrags-Nr.: AU-  
 Projekt-Nr.: PR-  
 Artikel-Nr.: 517063  
 Serien-Nr.:

**Solo-Rondomat**

Best.Var:  
 PCB-Artikelnr.: 000000

Kunde:  
 ---

	Datum	18.03.2019
	Bearb.	zaffral
	Gepr.	
Änderung	Datum	Name
	Norm	

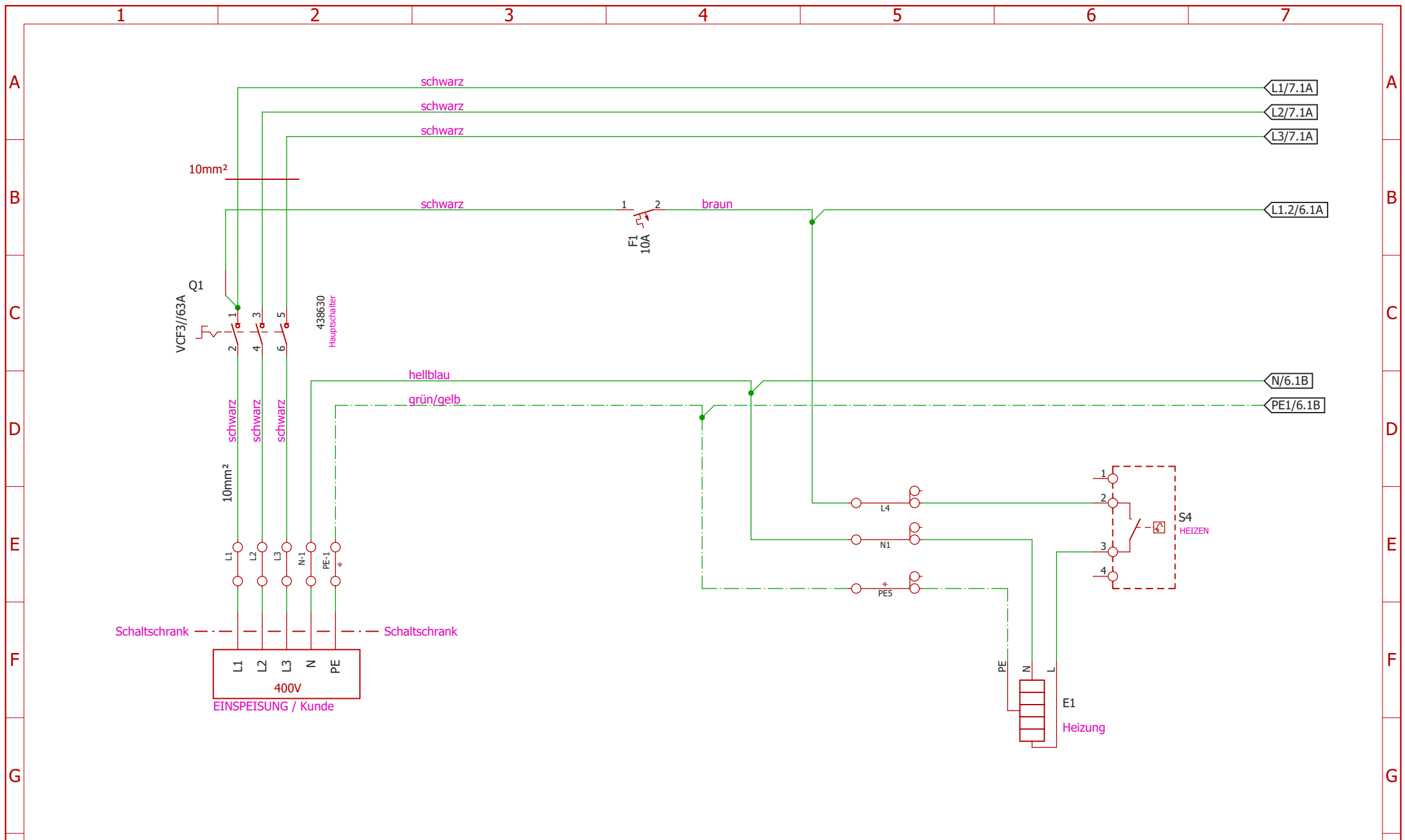

### Einspeisung / Schrankheizung

Dateiname: Solo-Rondomat\_600\_2019-03-25

Auftrags-Nr.: AU-  
 Projekt-Nr.: PR-  
 Artikel-Nr.: 517063  
 Serien-Nr.:

Solo-Rondomat

Best.Var:  
 PCB-Artikelnr.: 000000

Blatt 5 von 21

Katalog-Nr.:



Kunde:  
 ---

Datum: 18.03.2019  
 Bearb.: zaffral  
 Gepr.:

Änderung	Datum	Name	Norm
1			

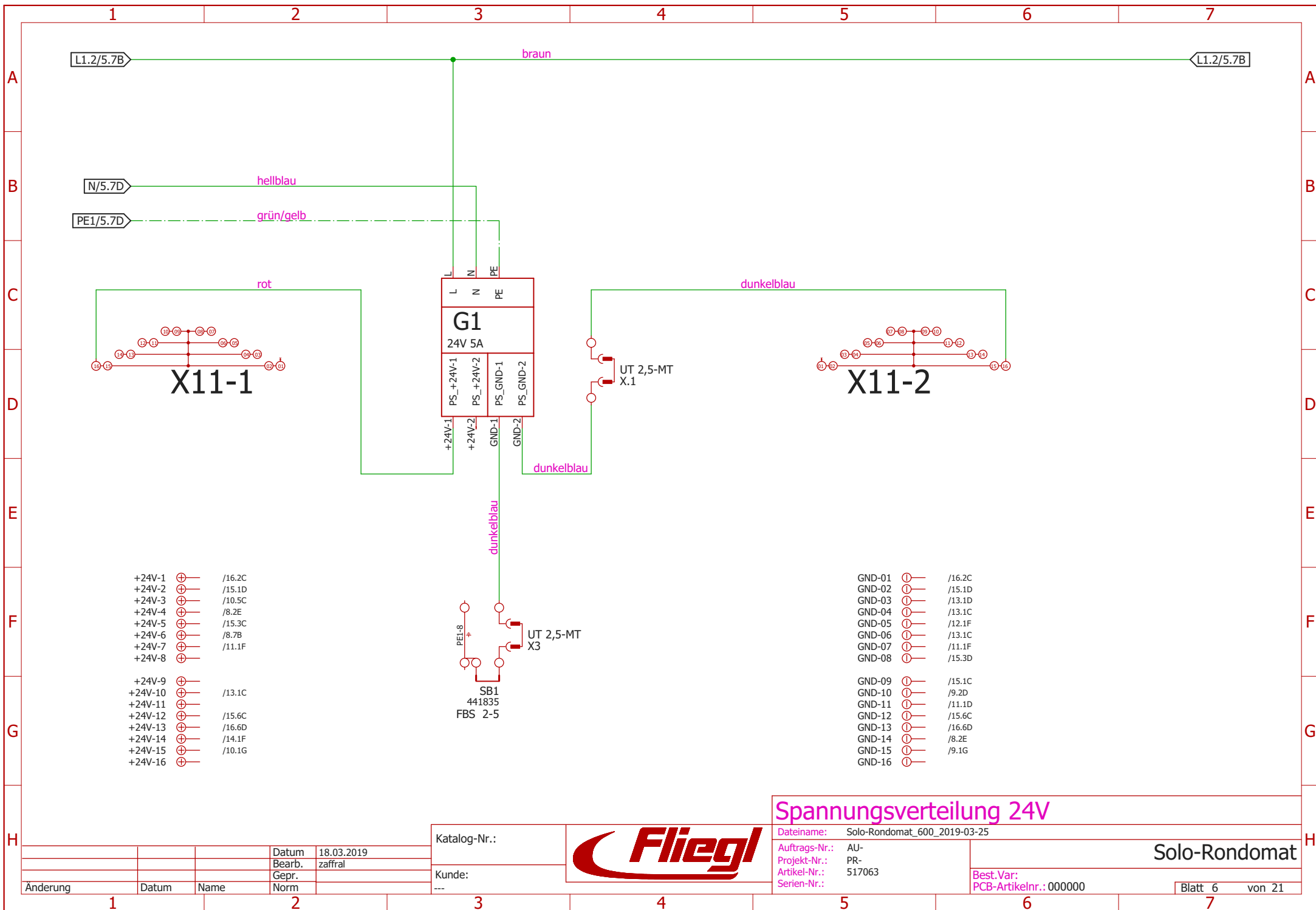

- +24V-1 ⊕ /16.2C
- +24V-2 ⊕ /15.1D
- +24V-3 ⊕ /10.5C
- +24V-4 ⊕ /8.2E
- +24V-5 ⊕ /15.3C
- +24V-6 ⊕ /8.7B
- +24V-7 ⊕ /11.1F
- +24V-8 ⊕
- +24V-9 ⊕
- +24V-10 ⊕ /13.1C
- +24V-11 ⊕
- +24V-12 ⊕ /15.6C
- +24V-13 ⊕ /16.6D
- +24V-14 ⊕ /14.1F
- +24V-15 ⊕ /10.1G
- +24V-16 ⊕

- GND-01 ⊖ /16.2C
- GND-02 ⊖ /15.1D
- GND-03 ⊖ /13.1D
- GND-04 ⊖ /13.1C
- GND-05 ⊖ /12.1F
- GND-06 ⊖ /13.1C
- GND-07 ⊖ /11.1F
- GND-08 ⊖ /15.3D
- GND-09 ⊖ /15.1C
- GND-10 ⊖ /9.2D
- GND-11 ⊖ /11.1D
- GND-12 ⊖ /15.6C
- GND-13 ⊖ /16.6D
- GND-14 ⊖ /8.2E
- GND-15 ⊖ /9.1G
- GND-16 ⊖

### Spannungsverteilung 24V

Dateiname: Solo-Rondomat_600_2019-03-25		<b>Solo-Rondomat</b>	
Auftrags-Nr.: AU-	Projekt-Nr.: PR-	Best.Var: PCB-Artikelnr.: 000000	
Artikel-Nr.: 517063	Series-Nr.:		
Blatt 6 von 21			

Katalog-Nr.:

Kunde: ---

Änderung	Datum	Name	Norm	Datum	18.03.2019
				Bearb.	zaffral
				Gepr.	

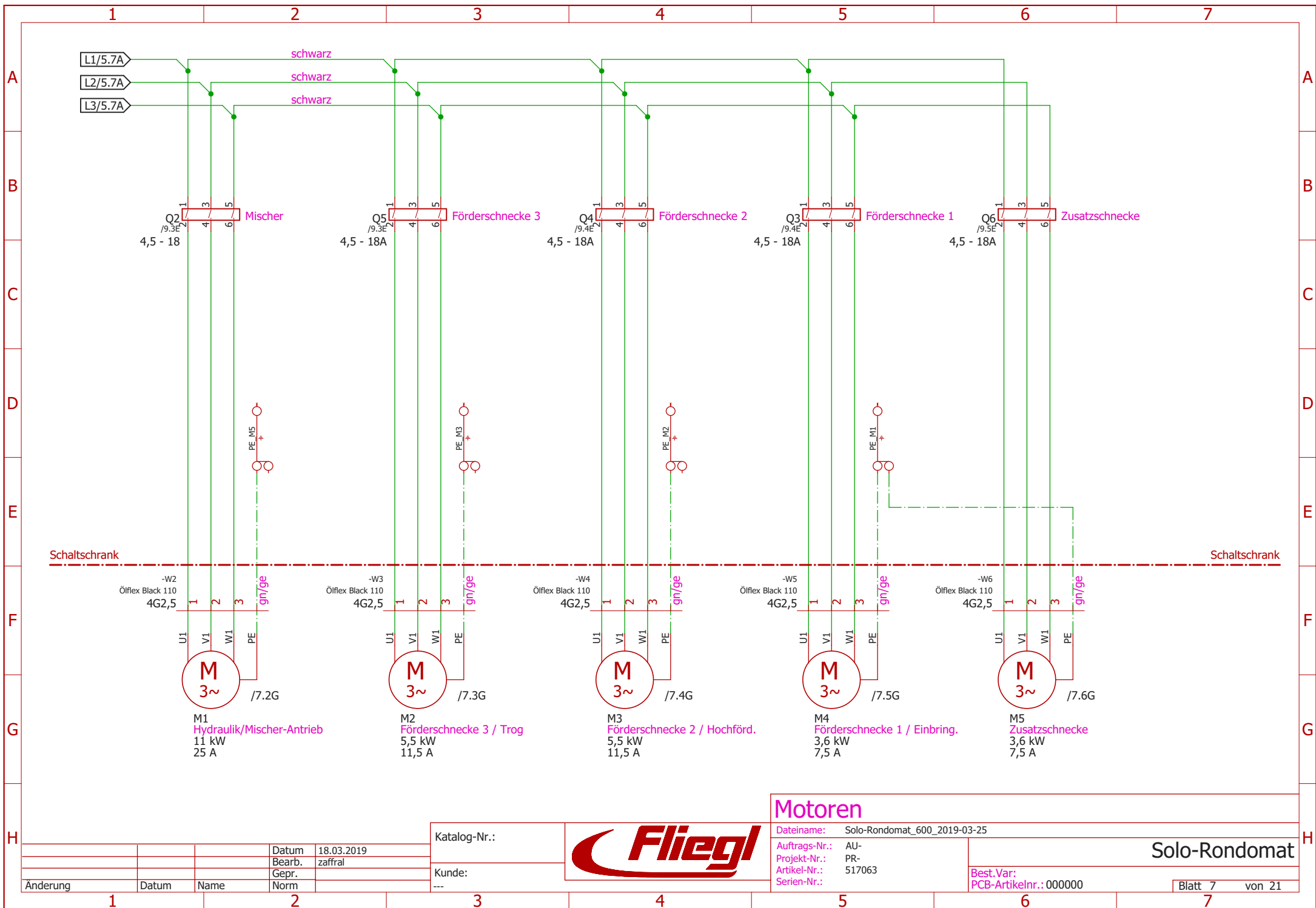

Schaltschrank

Schaltschrank

-W2  
Ölflex Black 110  
4G2,5

-W3  
Ölflex Black 110  
4G2,5

-W4  
Ölflex Black 110  
4G2,5

-W5  
Ölflex Black 110  
4G2,5

-W6  
Ölflex Black 110  
4G2,5

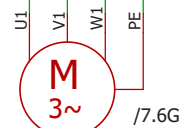
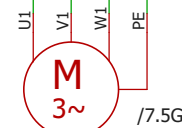
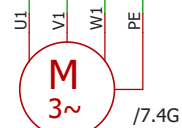
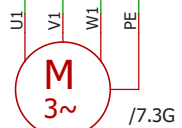

**M**  
3~  
/7.2G  
M1  
Hydraulik/Mischer-Antrieb  
11 kW  
25 A

**M**  
3~  
/7.3G  
M2  
Förderschnecke 3 / Trog  
5,5 kW  
11,5 A

**M**  
3~  
/7.4G  
M3  
Förderschnecke 2 / Hochförd.  
5,5 kW  
11,5 A

**M**  
3~  
/7.5G  
M4  
Förderschnecke 1 / Einbring.  
3,6 kW  
7,5 A

**M**  
3~  
/7.6G  
M5  
Zusatzschnecke  
3,6 kW  
7,5 A

### Motoren

Dateiname: Solo-Rondomat\_600\_2019-03-25  
 Auftrags-Nr.: AU-  
 Projekt-Nr.: PR-  
 Artikel-Nr.: 517063  
 Serien-Nr.:

Solo-Rondomat

Best.Var:  
PCB-Artikelnr.: 000000

Katalog-Nr.:	Datum	18.03.2019
	Bearb.	zaffral
	Gepr.	
Änderung	Datum	Name
1		
2		
3		
4		
5		
6		
7		



Kunde:  
---

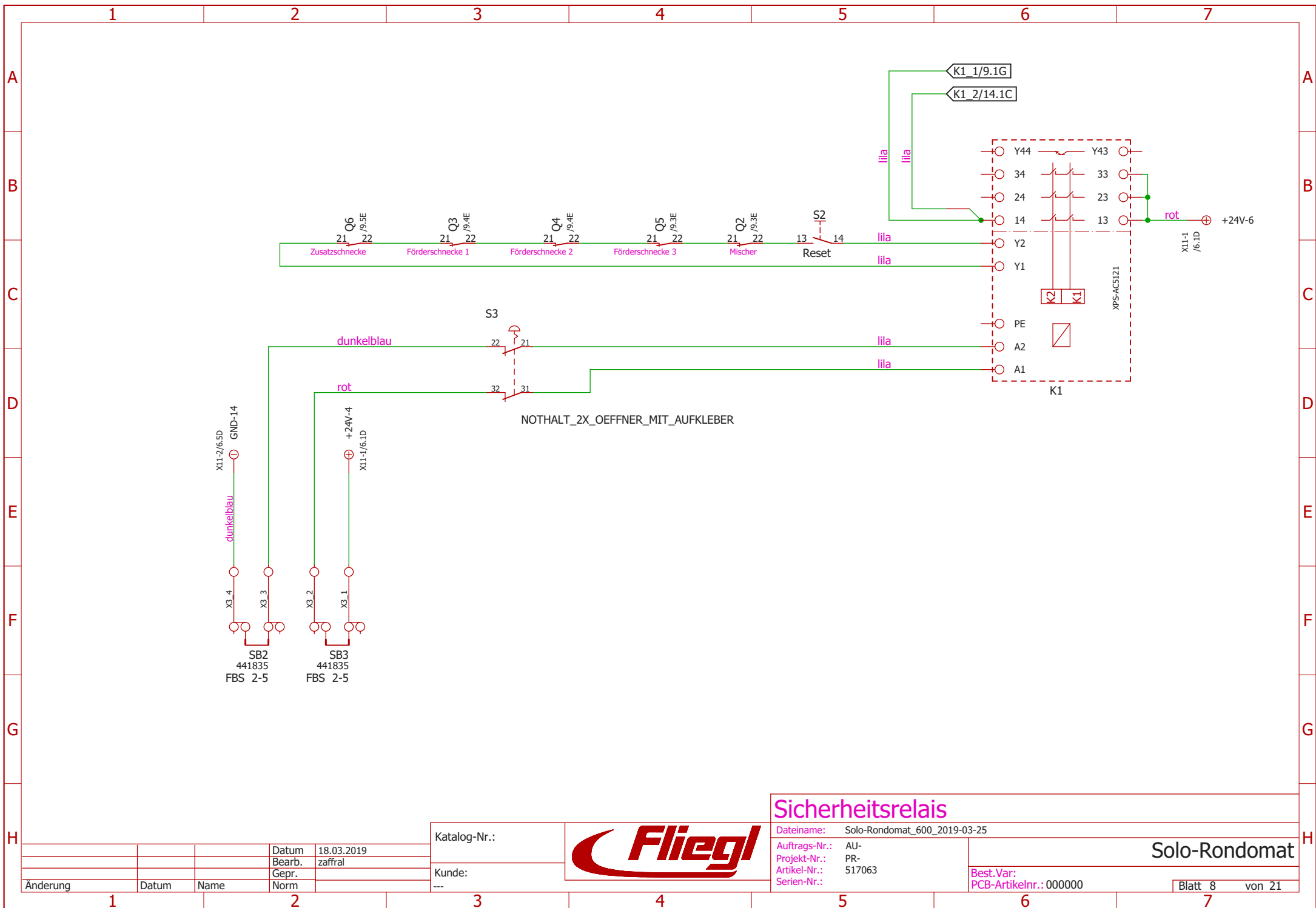

### Sicherheitsrelais

Katalog-Nr.:  
Kunde: ---



Dateiname: Solo-Rondomat\_600\_2019-03-25  
 Auftrags-Nr.: AU-  
 Projekt-Nr.: PR-  
 Artikel-Nr.: 517063  
 Serien-Nr.:

Solo-Rondomat

Best.Var:  
PCB-Artikelnr.: 000000

Änderung	Datum	Name	Norm

Datum: 18.03.2019  
 Bearb.: zaffral  
 Gepr.:



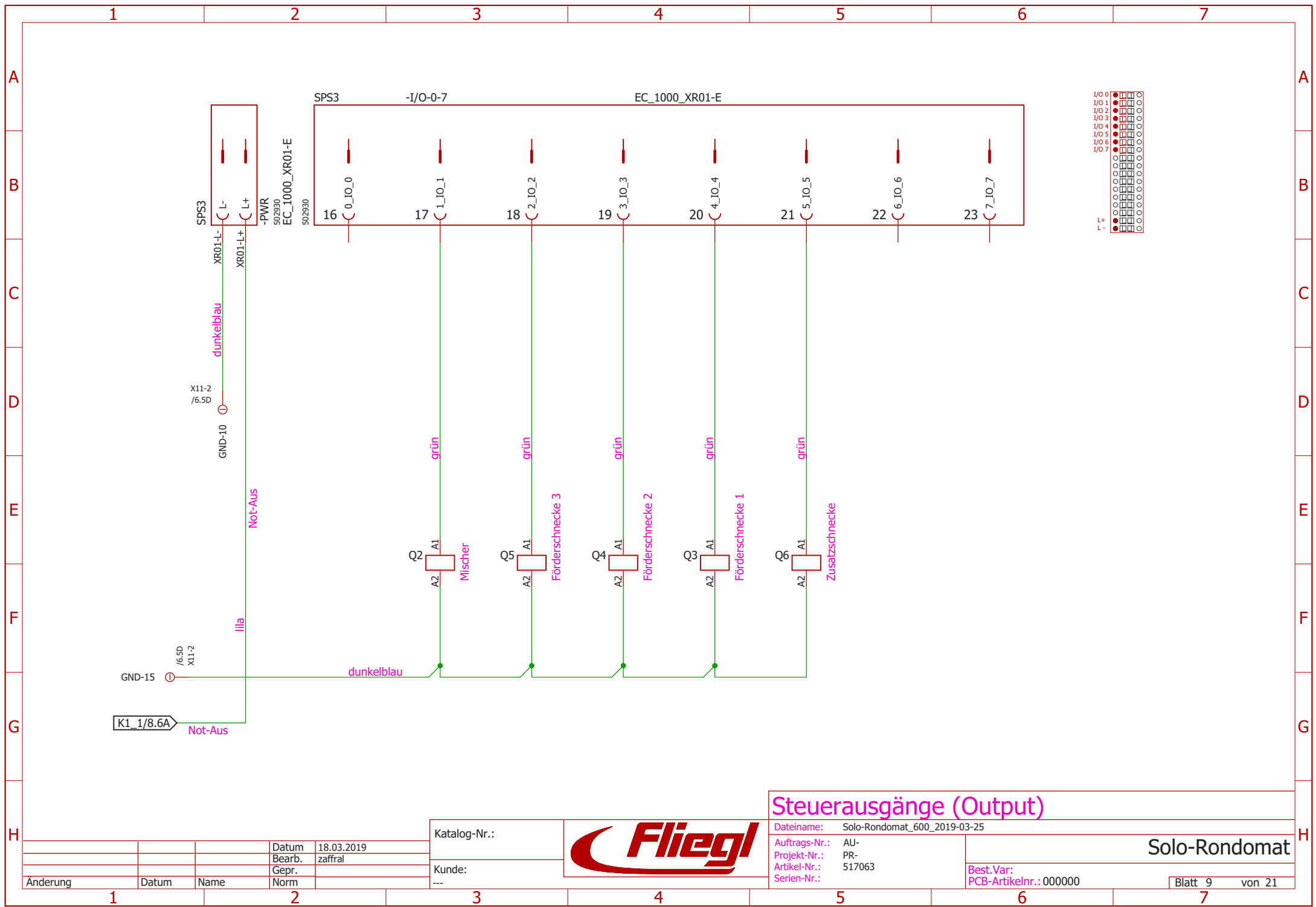

### Steuerausgänge (Output)

Dateiname:	Solo-Rondomat_600_2019-03-25	
Auftrags-Nr.:	AU-	<b>Solo-Rondomat</b>
Projekt-Nr.:	PR-	
Artikel-Nr.:	517063	
Serien-Nr.:		
Best.Var:	PCB-Artikelnr.: 000000	
		Blatt 9 von 21



Katalog-Nr.:	
Kunde:	---

Datum	18.03.2019
Bearb.	zaffral
Gepr.	
Norm	
Änderung	Datum Name

SPS3-I-8-15  
 EC\_1000\_XR01-E  
 502930

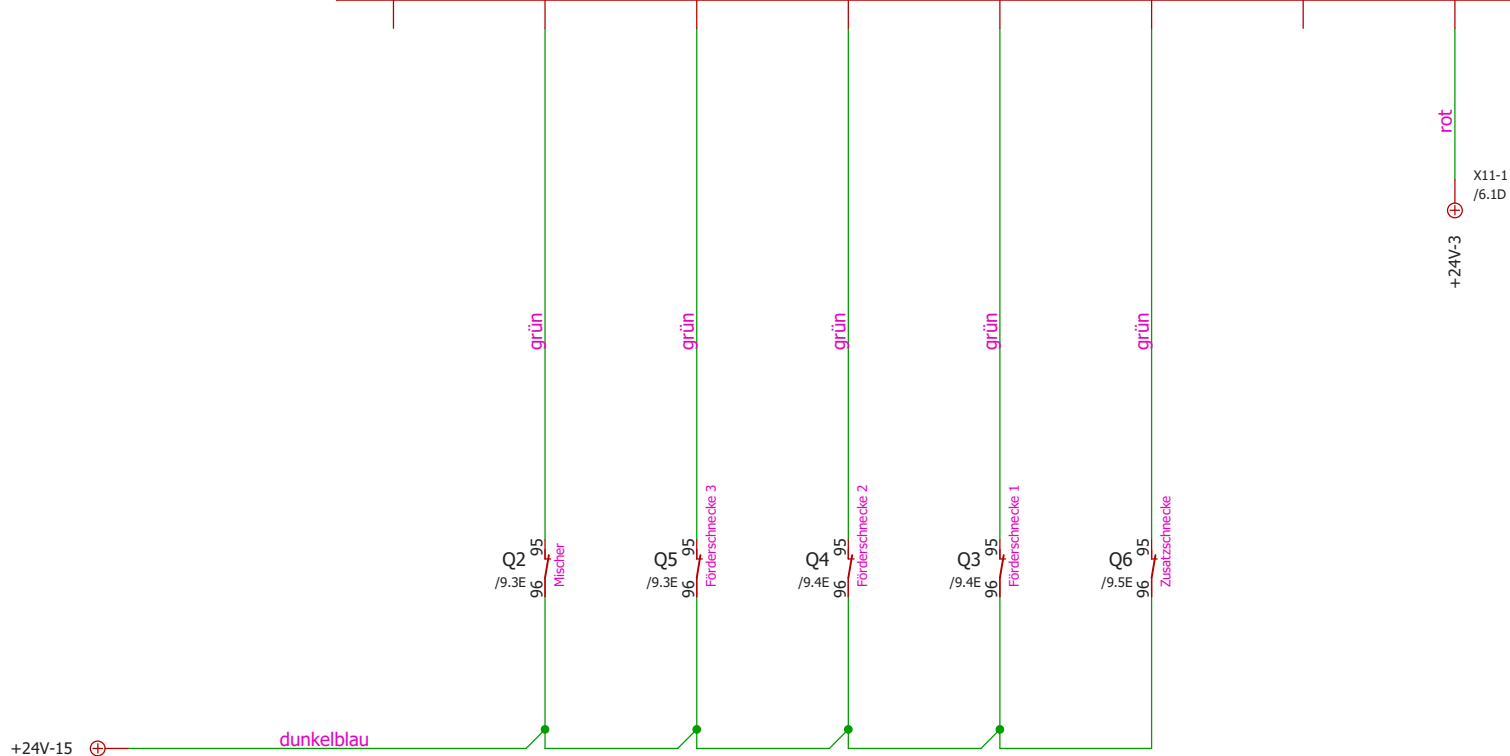
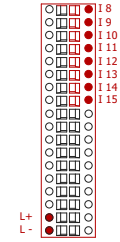
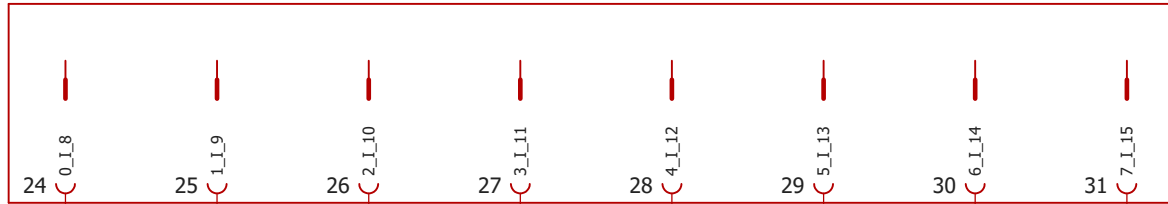

+24V-15 ⊕  
 /6.1D  
 X11-1

X11-1  
 /6.1D  
 +24V-3 ⊕  
 rot

Q2 95 /9.3E 96 Mischer  
 Q5 95 /9.3E 96 Förderschnecke 3  
 Q4 95 /9.4E 96 Förderschnecke 2  
 Q3 95 /9.4E 96 Förderschnecke 1  
 Q6 95 /9.5E 96 Zusatzschnecke

dunkelblau

### Störungen (Input)

Änderung	Datum	Name	Norm

Katalog-Nr.:  
 Kunde:  
 ---



Dateiname: Solo-Rondomat\_600\_2019-03-25  
 Auftrags-Nr.: AU-  
 Projekt-Nr.: PR-  
 Artikel-Nr.: 517063  
 Serien-Nr.:

Solo-Rondomat  
 Best.Var:  
 PCB-Artikelnr.: 000000  
 Blatt 10 von 21

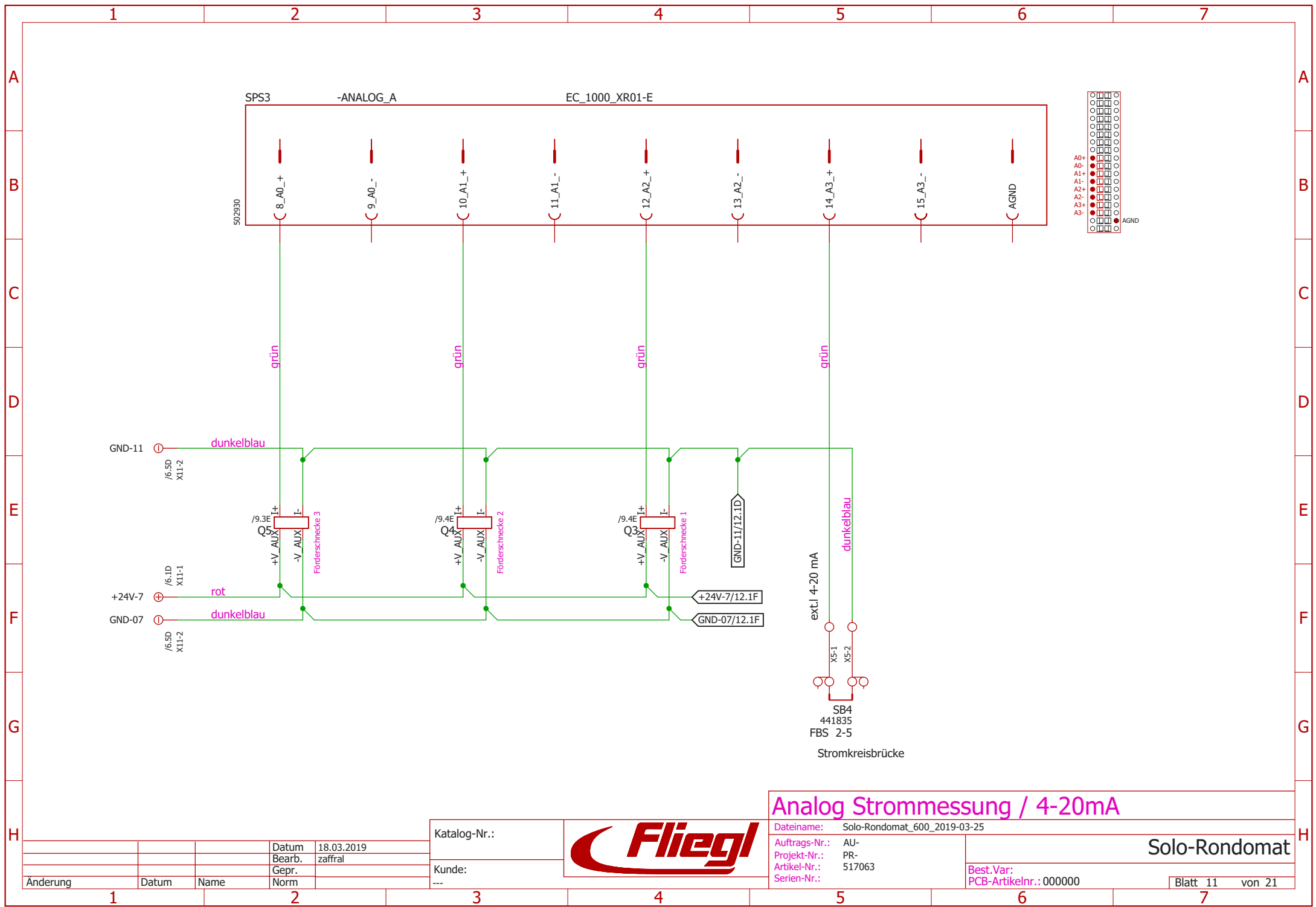

**Analog Strommessung / 4-20mA**

Dateiname: Solo-Rondomat\_600\_2019-03-25

Auftrags-Nr.: AU-  
 Projekt-Nr.: PR-  
 Artikel-Nr.: 517063  
 Serien-Nr.:

**Solo-Rondomat**

Best.Var:  
 PCB-Artikelnr.: 000000

Blatt 11 von 21

Katalog-Nr.:

**Fliegl**

Kunde: ---

Datum	18.03.2019
Bearb.	zaffral
Gepr.	
Norm	
Änderung	Datum Name

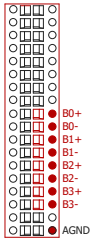
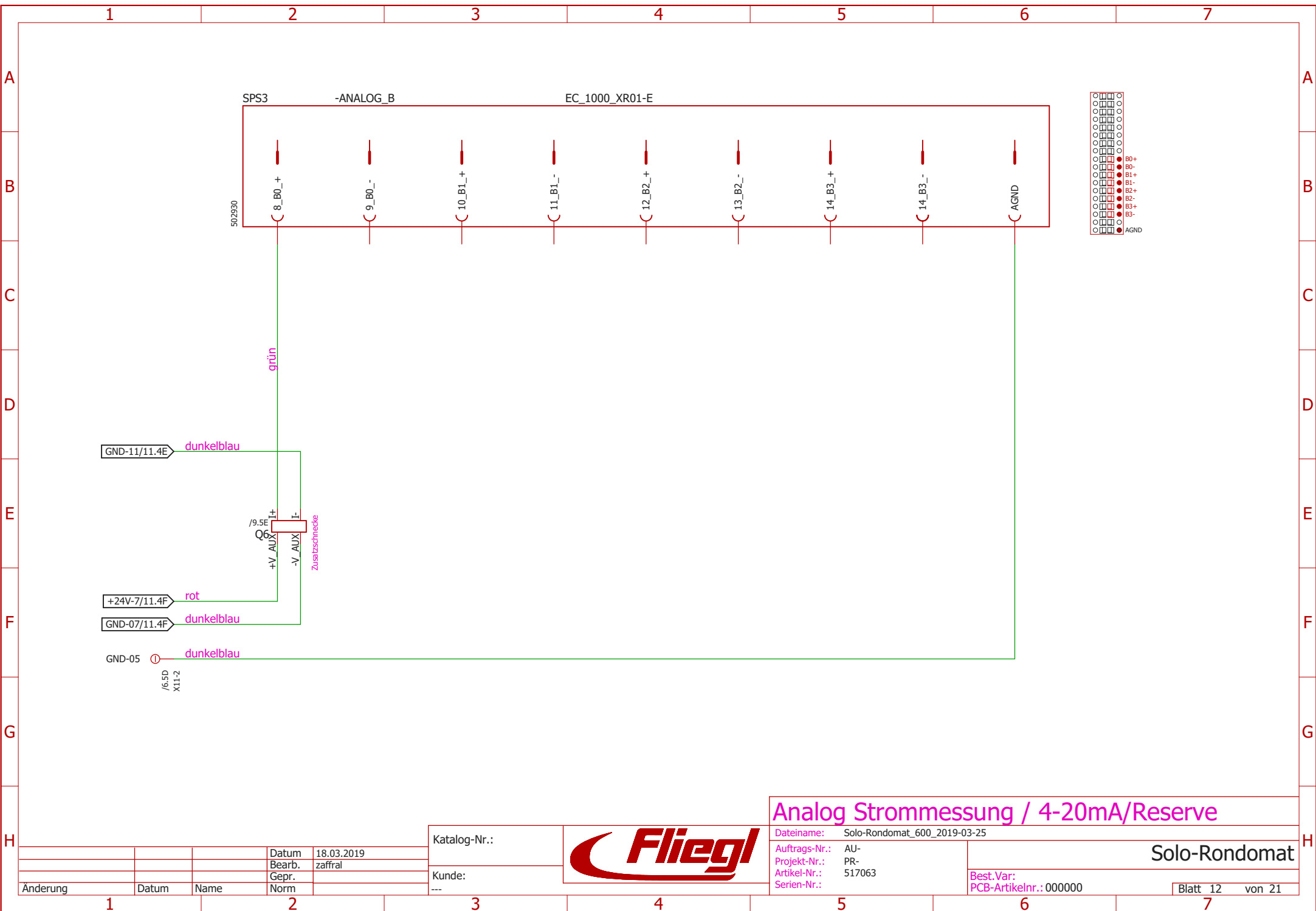

### Analog Strommessung / 4-20mA/Reserve

Katalog-Nr.:  
Kunde: ---



Dateiname: Solo-Rondomat\_600\_2019-03-25  
 Auftrags-Nr.: AU-  
 Projekt-Nr.: PR-  
 Artikel-Nr.: 517063  
 Serien-Nr.:

Solo-Rondomat

Best.Var:  
PCB-Artikelnr.: 000000

Änderung	Datum	Name	Norm

Datum 18.03.2019  
 Bearb. zaffral  
 Gepr.:

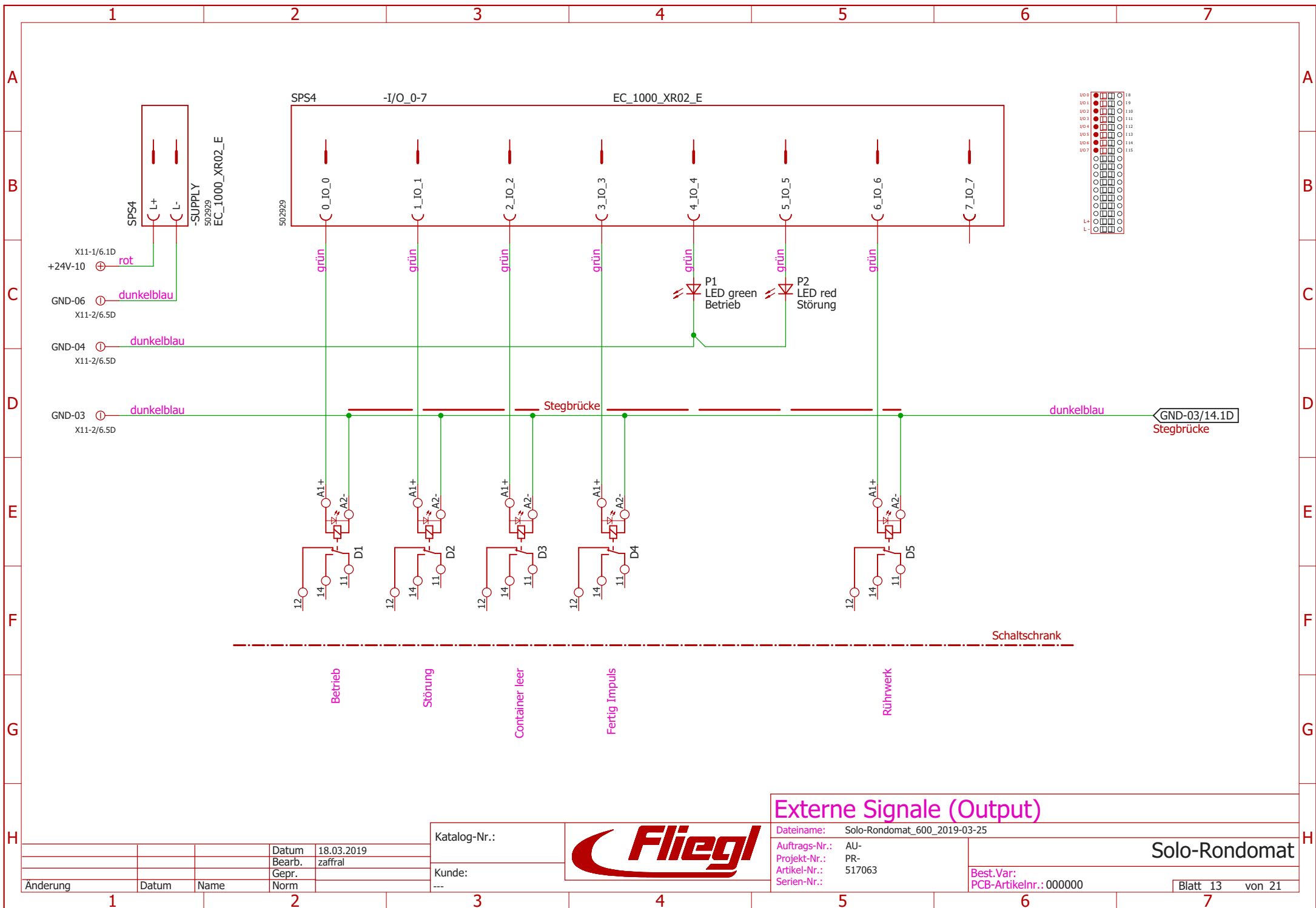

### Externe Signale (Output)

Katalog-Nr.: **Fliegl**

Datum: 18.03.2019  
 Bearb.: zaffral

Kunde: ---

Dateiname: Solo-Rondomat\_600\_2019-03-25

Auftrags-Nr.: AU-  
 Projekt-Nr.: PR-  
 Artikel-Nr.: 517063

Solo-Rondomat

Best.Var:  
 PCB-Artikelnr.: 000000

Blatt 13 von 21

Änderung	Datum	Name	Norm

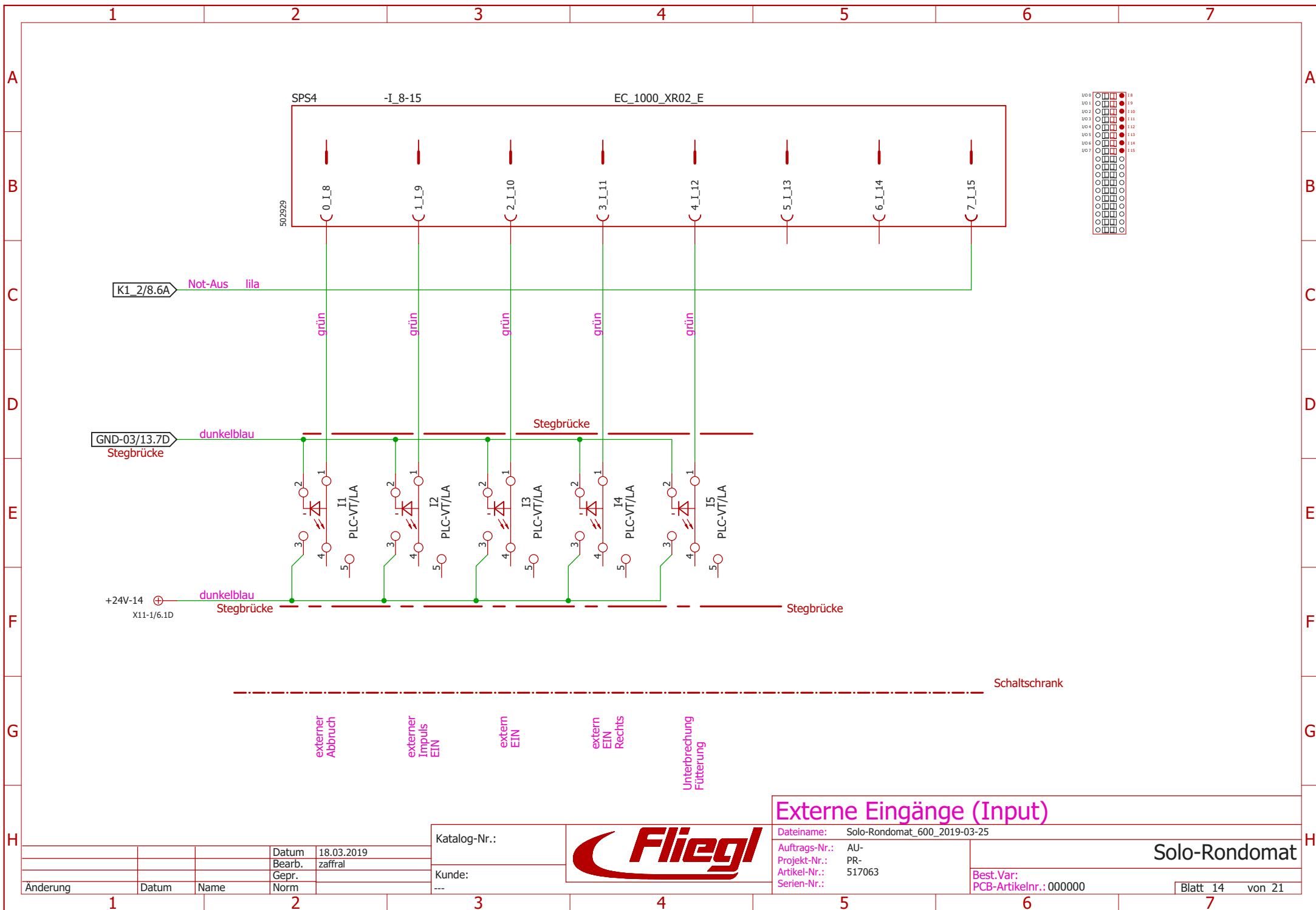

externer Abbruch  
 externer Impuls EIN  
 extern EIN  
 extern EIN Rechts  
 Unterbrechung Fütterung

Externe Eingänge (Input)	
Dateiname:	Solo-Rondomat_600_2019-03-25
Auftrags-Nr.:	AU-
Projekt-Nr.:	PR-
Artikel-Nr.:	517063
Serien-Nr.:	
Best.Var:	
PCB-Artikelnr.:	000000

Katalog-Nr.:	
Kunde:	---



Änderung	Datum	Name	Norm

Solo-Rondomat

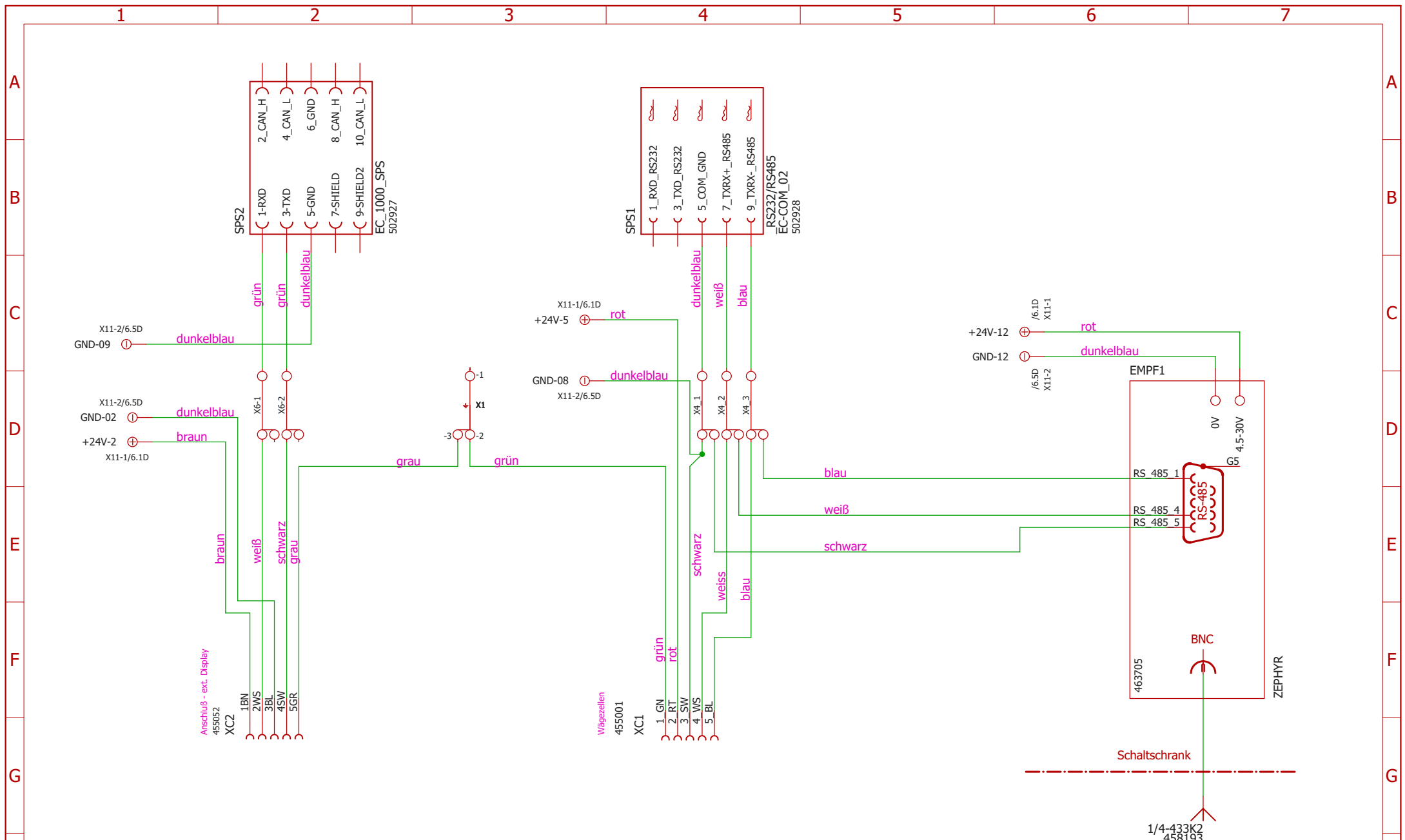

<b>CAN-BUS / Ext. Display / Funk</b>		Dateiname: Solo-Rondomat_600_2019-03-25
Auftrags-Nr.: AU-		Solo-Rondomat
Projekt-Nr.: PR-		
Artikel-Nr.: 517063		
Serien-Nr.:		
Best.Var: PCB-Artikelnr.: 000000		Blatt 15 von 21



Katalog-Nr.:		Datum: 18.03.2019
Kunde: ---		Bearb.: zaffral
Änderung	Datum	Name
1		
2		
3		
4		
5		
6		
7		

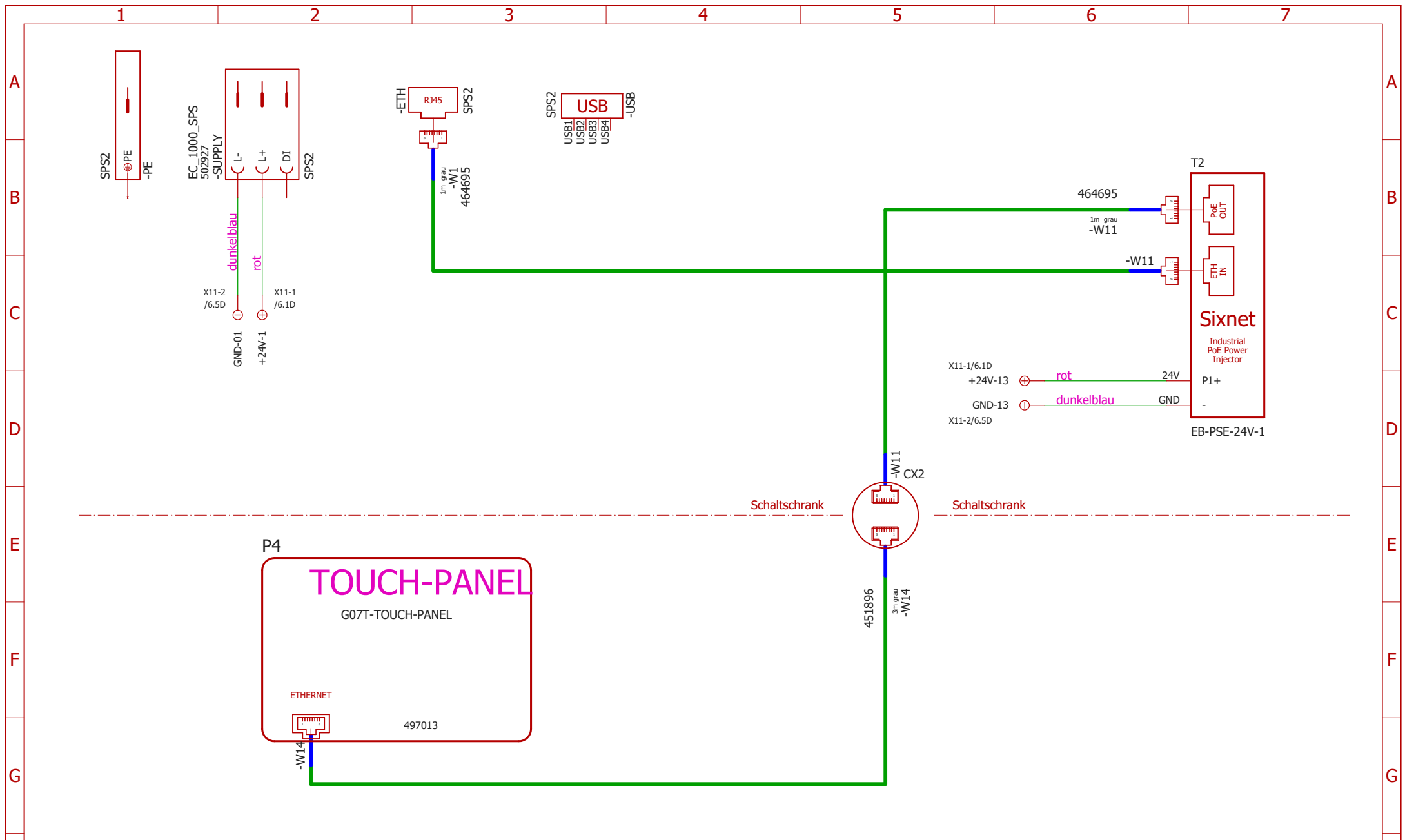











Änderung		Datum	Name	Norm	Katalog-Nr.:	Touchpanel	
						Dateiname:	Solo-Rondomat_600_2019-03-25
			Datum	18.03.2019	Kunde:	Auftrags-Nr.:	AU-
			Bearb.	zaffral		Projekt-Nr.:	PR-
			Gepr.			Artikel-Nr.:	517063
					---	Serien-Nr.:	
						Best.Var:	
						PCB-Artikelnr.: 000000	
						Blatt 16 von 21	



Solo-Rondomat



	1	2	3	4	5	6	7				
A	SH1	480724	SCHALTSCHRANK 603 X 603 X 300	KV1	452045	⊗	KABELVERSCHRAUBUNG M32X1,5	AH1	438843		Clipfix 9,5mm
	MECH1	504735	Montageplatte 550 x 550 x 3	KVM1	437227	⊗	MUTTER M32X1,5				
	MECH2	438813	Hutschiene TS 35x15/LL	TS 35x15/LL 540mm	KV2	438815	⊗	VERSCHRAUBUNG M25X1,5	A1	462661	
	MECH3	438813	Hutschiene TS 35x15/LL	TS 35x15/LL 540mm	KVM2	441315	⊗	MUTTER M25X1,5			
B	AK1	430522	AUFKLEBER_FLIEGL_REFLEKTIERBAR_40X11	KV3	438815	⊗	VERSCHRAUBUNG M25X1,5	AH4	438843		Clipfix 9,5mm
	AK2	471921	AUFKLEBER_KABELVERLEGUNG_NICHT_PARALLEL	KVM3	441315	⊗	MUTTER M25X1,5	A2	462661		Clipfix 5mm
	AK3	468920	AUFKLEBER_ENDKONTROLLE_KLEIN	KV4	438815	⊗	VERSCHRAUBUNG M25X1,5	A3	462661		Clipfix 5mm
	AK4	431533	AUFKLEBER_WARNING_VOR_ELEKTRO_SPANNUNG	KVM4	441315	⊗	MUTTER M25X1,5	A4	462661		Clipfix 5mm
	AK5	463809	DREHRICHTUNGSPFEIL_FUER_MOTOREN	KV5	438815	⊗	VERSCHRAUBUNG M25X1,5	A5	462661		Clipfix 5mm
	KA1	457649	KONDENSATABLAUF	KVM5	441315	⊗	MUTTER M25X1,5	A6	462661		Clipfix 5mm
C				KV6	438815	⊗	VERSCHRAUBUNG M25X1,5	A7	462661		Clipfix 5mm
				KVM6	441315	⊗	MUTTER M25X1,5	A8	462661		Clipfix 5mm
				KV7	457260	⊗	VERSCHRAUBUNG M16X1,5	A9	462661		Clipfix 5mm
				KVM7	457260	⊗	VERSCHRAUBUNG M16X1,5	A10	462661		Clipfix 5mm
				KV8	457260	⊗	VERSCHRAUBUNG M16X1,5	A11	462661		Clipfix 5mm
				KVM8	457260	⊗	VERSCHRAUBUNG M16X1,5	A12	462661		Clipfix 5mm
				KV9	457260	⊗	VERSCHRAUBUNG M16X1,5	A13	462661		Clipfix 5mm
				KVM9	457260	⊗	VERSCHRAUBUNG M16X1,5	DK1	441829		D-UT 2,5/4-TWIN
				KV10	457260	⊗	VERSCHRAUBUNG M16X1,5	DK2	441829		D-UT 2,5/4-TWIN
				KVM10	457260	⊗	VERSCHRAUBUNG M16X1,5	DK3	441829		D-UT 2,5/4-TWIN
	D	Litze	457842	H0_5V-K_DUNKELBLAU	KV11	457260	⊗	VERSCHRAUBUNG M16X1,5	DK4	441829	
Litze		458006	H0_5V-K_DUNKELBLAU/WEISS	KVM11	457260	⊗	VERSCHRAUBUNG M16X1,5	DK5	441829		D-UT 2,5/4-TWIN
Litze		457845	H0_5V-K_GELB/GRUEN-1QMM					DK6	442905		D-UT 2,5/10
Litze		457841	H0_5V-K_HELLBLAU-1QMM								
Litze		457843	H0_5V-K_ORANGE-1QMM								
Litze		457840	H0_5V-K_SCHWARZ-1QMM								
Litze		457189	H0_7V-K10_GELB/GRUEN-10QMM								
Litze		439146	H0_7V-K_SCHWARZ-10QMM								
Litze		439148	H0_7V-K_SCHWARZ-2,5QMM								
AEH1		439719	1X0,5QMM_L=8MM_WEISS								
AEH2	439713	1X1QMM_L=8MM_ROT									
AEH3	439709	1X2,5QMM_L=8MM_BLAU									
AEH4	439708	1X10QMM_L=12MM_ROT									
AEH5	439712	2X1QMM_L=8MM_ROT									
AEH6	439703	2X10QMM_L=14MM_ROT									
FSH1	442141	FLACHSTECKHUELSEN_0,5-1QMM									
KSH1	463192	PRESSKABELSCHUH_M8									
G	ROH1	440562	Rohrhalter 29mm								
	ROH2	440562	Rohrhalter 29mm								
	ISOL2	440561	KUNSTSTOFFISOLIERROHR_29MM								
BR1	463304	ENDLOSSBRUECKE_BLAU									
H	SDI KARTE_1GB SDI			Katalog-Nr.:				Dateiname: Solo-Rondomat_600_2019-03-25		Solo-Rondomat	
	Änderung		Datum	Name	Norm			Kunde: ---	Auftrags-Nr.: AU- Projekt-Nr.: PR- Artikel-Nr.: 517063 Serien-Nr.:		

	1	2	3	4	5	6	7
A	ZB1 ZB2	453816 453816	PE PE	MECH6 439740	 STOP-TASTE-RASTEND_SCHWAMM(ROT)		
	ZB4 ZB5 ZB6 ZB7 ZB8	453816 453816 453816 453816 453816	PE PE PE PE PE	MECH19 462554	 STOP-TASTE-GELB_KREIS		
B	ZB9	438852	L1 L2 L3 N PE KKKKK	KSR1 456297	 KUNSTSTOFFSCHILDER_RESET		
	ZB10	464174	N	SH20 455199	 CARRIER-EMP_22		
C	ZB11	438852	L1	KSE1 455200	 KUNSTSTOFFSCHILDER_AUS-EIN		
	ZB12	464176	-	SH19 455199	 CARRIER-EMP_22		
	ZB13	464176	-	SH5 455199	 CARRIER-EMP_22		
	ZB14	438856	1	KSB2 456296	 KUNSTSTOFFSCHILDER_BETRIEB		
	ZB15	438856	2	SH53 455199	 CARRIER-EMP_22		
	ZB16	438856	3	KSS2 456295	 KUNSTSTOFFSCHILDER_STOERUNG		
D	ZB17	438856	1				
	ZB18	438856	2				
	ZB19	438856	3				
	ZB20	438856	4				
E	ZB21	453815	d1				
	ZB22	453819	d2				
	ZB23	453820	d3				
	ZB24	453821	d4				
	ZB25	453822	d5				
	ZB26	453824	i1				
	ZB27	453825	i2				
	ZB28	453826	i3				
	ZB29	453827	i4				
	ZB30	453828	i5				
F	ZB31	438856	1				
	ZB32	438856	2				
	ZB33	438856	1				
	ZB34	438856	2				
	KT1	462703					
	KT2	462703					
	KT3	462703					
	KT4	462703					
	KT5	462703					
	KT6	462703					
	KT7	462703					
	KT8	462703					
	KT9	462703					
	KT10	462703					
H				Katalog-Nr.:			
				Kunde:			
				Datum	Dateiname: Solo-Rondomat_600_2019-03-25		
				Bearb.	Auftrags-Nr.: AU-		
				Gepr.	Projekt-Nr.: PR-		
				Norm	Artikel-Nr.: 517063		
Änderung	Datum	Name	Norm	---	Best.Var:		Solo-Rondomat
1				3	PCB-Artikelnr.: 000000		Blatt 18 von 21

Qty.	Article	Value	Part (s)
2	464695	1m grau	-W1, -W11
1	451896	3m grau	-W14
13	462661	Clipfix 5mm	A1, A2, A3, A4, A5, A6, A7, A8, A9, A10, A11, A12, A13
1	439719	1X0,5QMM L=8MM WEISS	AEH1
1	439713	1X1QMM L=8MM ROT	AEH2
1	439709	1X2,5QMM L=8MM BLAU	AEH3
1	439708	1X10QMM L=12MM ROT	AEH4
1	439712	2X1QMM L=8MM ROT	AEH5
1	439703	2X10QMM L=14MM ROT	AEH6
2	438843	Clipfix 9,5mm	AH1, AH4
1	430522	AUFKLEBER FLIEGL REFLEKTIERBAR 40X11	AK1
1	471921	AUFKLEBER KABELVERLEGUNG NICHT PARALLEL	AK2
1	468920	AUFKLEBER ENDKONTROLLE KLEIN	AK3
1	431533	AUFKLEBER WARNING VOR ELEKTRO SPANNUNG	AK4
1	463809	DREHRICHTUNGSPFEIL FUER MOTOREN	AK5
1	458193	1/4-433K2	ANT1
1	463304	ENDLOSSBRUECKE BLAU	BR1
1	488290	RJ45 F/F 8/8 CAT.5E	CX2
5	457622	PLC-RSC- 24DC/21AU	D1, D2, D3, D4, D5
5	441829	D-UT 2,5/4-TWIN	DK1, DK2, DK3, DK4, DK5
1	442905	D-UT 2,5/10	DK6
1	457842	H0 5V-K DUNKELBLAU	DRAHT1
1	458006	H0 5V-K DUNKELBLAU/WEISS	DRAHT2
1	457845	H0 5V-K GELB/GRUEN-1QMM	DRAHT3
1	457841	H0 5V-K HELLBLAU-1QMM	DRAHT4
1	457840	H0 5V-K SCHWARZ-1QMM	DRAHT5
1	457189	H0 7V-K10 GELB/GRUEN-10QMM	DRAHT6
1	439146	H0 7V-K SCHWARZ-10QMM	DRAHT7
1	439148	H0 7V-K SCHWARZ-2,5QMM	DRAHT8
1	457843	H0 5V-K ORANGE-1QMM	DRAHT9
1	452390	30W	E1
1	463705	ZEPHYR	EMPF1
1	439687	10A	F1
1	442141	FLACHSTECKHUELSEN 0,5-1QMM	FSH1
1	485678	24V 5A	G1
5	457621	PLC-VT/LA	I1, I2, I3, I4, I5
1	440561	KUNSTSTOFFISOLIERROHR 29MM	ISOL2
1	480470	XPS-AC5121	K1
1	457649	KONDENSATABLAUF	KA1

## Stückliste

Stückliste erzeugt : 25.03.2019 13:03:30

Katalog-Nr.:



Dateiname: Solo-Rondomat\_600\_2019-03-25

Auftrags-Nr.: AU-  
 Projekt-Nr.: PR-  
 Artikel-Nr.: 517063  
 Serien-Nr.:

Solo-Rondomat

Änderung	Datum	Name	Norm

Kunde:  
---

Best.Var:  
PCB-Artikelnr.: 000000

	1	2	3	4	5	6	7																
A	Qty.	Article	Value	Part (s)																			
	1	456296	KUNSTSTOFFSCHILDER BETRIEB	KSB2																			
	1	455200	KUNSTSTOFFSCHILDER AUS-EIN	KSE1																			
	1	463192	PRESSKABELSCHUH M8	KSH1																			
	1	456297	KUNSTSTOFFSCHILDER RESET	KSR1																			
	1	456295	KUNSTSTOFFSCHILDER STOERUNG	KSS2																			
	B	10	462703	KLM 3-L	KT1,KT2,KT3,KT4,KT5,KT6,KT7,KT8,KT9,KT10																		
		1	452045	KABELVERSCHRAUBUNG M32X1,5	KV1																		
		5	438815	VERSCHRAUBUNG M25X1,5	KV2,KV3,KV4,KV5,KV6																		
		10	457260	VERSCHRAUBUNG M16X1,5	KV7,KV8,KV9,KV10,KV11,KVM7,KVM8,KVM9,KVM10,KVM11																		
1		437227	MUTTER M32X1,5	KVM1																			
5		441315	MUTTER M25X1,5	KVM2,KVM3,KVM4,KVM5,KVM6																			
C		3	442886	UT 10	L1,L2,L3																		
		12	441825	UT 2,5-TWIN	L4,X3 1,X3 2,X3 3,X3 4,X4 1,X4 2,X4 3,X5-1,X5-2,X6-1,X6-2																		
		1	504735	MONTAGEPLATTE 550X550X3MM	MECH1																		
		1	462554	STOP-TASTE-GELB KREIS	MECH19																		
	2	438813	TS 35x15/LL 540mm	MECH2,MECH3																			
	1	439740	STOP-TASTE-RASTEND SCHWAMM (ROT)	MECH6																			
	D	1	442885	UT 10 BU	N-1																		
		1	441826	UT 2,5-TWIN BU	N1																		
		1	440289	LED green	P1																		
		1	440290	LED red	P2																		
1		497013	G07T-TOUCH-PANEL	P4																			
1		442884	UT 10-PE	PE-1																			
E		7	441827	UT 2,5-TWIN-PE	PE1-8,PE5,PE M1,PE M2,PE M3,PE M5,X1																		
		1	438630	VCF3//63A	Q1																		
		5	441043	LUCA32	Q2,Q3,Q4,Q5,Q6																		
		5	441044	LUCA32	Q2.1,Q3.1,Q4.1,Q5.1,Q6.1																		
	5	441040	LUCA32	Q2.2,Q3.2,Q4.2,Q5.2,Q6.2																			
	2	440562	Rohrhalter 29mm	ROH1,ROH2																			
	F	1	440288	XB5AP61 / BLAU	S2																		
		1	??????	XB5AP61 / BLAU	S2.1																		
		1	439768	NOTHALT 2X OEFFNER MIT AUFKLEBER	S3																		
		1	452522	NOTHALT 2X OEFFNER MIT AUFKLEBER	S3.1																		
1		439740	NOTHALT 2X OEFFNER MIT AUFKLEBER	S3.2																			
1		469741	NOTHALT 2X OEFFNER MIT AUFKLEBER	S3.3																			
1		459125	TEMP REG HEIZEN	S4																			
G		4	441835	FBS 2-5	SB1,SB2,SB3,SB4																		
		1	464736	SD KARTE 1GB	SD1																		
		1	480724	SCHALTSCHRANK 606X606X300_FLG-004	SH1																		
H	Stückliste erzeugt : 25.03.2019 13:03:30			Katalog-Nr.:		Dateiname: Solo-Rondomat_600_2019-03-25																	
	<table border="1"> <tr> <td>Datum</td> <td>18.03.2019</td> </tr> <tr> <td>Bearb.</td> <td>zaffral</td> </tr> <tr> <td>Gepr.</td> <td></td> </tr> <tr> <td>Norm</td> <td></td> </tr> </table>			Datum	18.03.2019	Bearb.	zaffral	Gepr.		Norm				<table border="1"> <tr> <td>Auftrags-Nr.:</td> <td>AU-</td> <td rowspan="4">Solo-Rondomat</td> </tr> <tr> <td>Projekt-Nr.:</td> <td>PR-</td> </tr> <tr> <td>Artikel-Nr.:</td> <td>517063</td> </tr> <tr> <td>Serien-Nr.:</td> <td></td> </tr> </table>		Auftrags-Nr.:	AU-	Solo-Rondomat	Projekt-Nr.:	PR-	Artikel-Nr.:	517063	Serien-Nr.:
Datum	18.03.2019																						
Bearb.	zaffral																						
Gepr.																							
Norm																							
Auftrags-Nr.:	AU-	Solo-Rondomat																					
Projekt-Nr.:	PR-																						
Artikel-Nr.:	517063																						
Serien-Nr.:																							
<table border="1"> <tr> <th>Änderung</th> <th>Datum</th> <th>Name</th> <th>Norm</th> </tr> <tr> <td>1</td> <td></td> <td></td> <td></td> </tr> </table>			Änderung	Datum	Name	Norm	1				Kunde: ---		Best.Var: PCB-Artikelnr.: 000000										
Änderung	Datum	Name	Norm																				
1																							
			Blatt 20		von 21																		

Qty.	Article	Value	Part (s)
4	455199	CARRIER-EMP 22	SH5, SH19, SH20, SH53
1	502928	EC-COM 02	SPS1
1	502927	EC 1000 SPS	SPS2
1	502930	EC 1000 XR01-E	SPS3
1	502929	EC 1000 XR02 E	SPS4
1	489058	EB-PSE-24V-1	T2
2	458836	UT 2,5-MT	X.1, X3
1	458210	24V-A-XX-	X11-1
1	458210	GND-A-XX-	X11-2
1	455001	RS485M12F	XC1
1	455052	M12F/5WANDDURCHFUEHRUNG	XC2
7	453816	PE	ZB1, ZB2, ZB4, ZB5, ZB6, ZB7, ZB8
1	464174	N	ZB10
1	438852	L1	ZB11
2	464176	-	ZB12, ZB13
4	438856	1	ZB14, ZB17, ZB31, ZB33
4	438856	2	ZB15, ZB18, ZB32, ZB34
2	438856	3	ZB16, ZB19
1	438856	4	ZB20
1	453815	d1	ZB21
1	453819	d2	ZB22
1	453820	d3	ZB23
1	453821	d4	ZB24
1	453822	d5	ZB25
1	453824	i1	ZB26
1	453825	i2	ZB27
1	453826	i3	ZB28
1	453827	i4	ZB29
1	453828	i5	ZB30
1	438852	ZACKBAND-5 10MM	ZB9

H Stückliste erzeugt : 25.03.2019 13:03:30

	Datum	18.03.2019
	Bearb.	zaffral
	Gepr.	
Änderung	Datum	Name
	Norm	

Katalog-Nr.:  
Kunde:  
---



### Stückliste

Dateiname: Solo-Rondomat\_600\_2019-03-25  
 Auftrags-Nr.: AU-  
 Projekt-Nr.: PR-  
 Artikel-Nr.: 517063  
 Serien-Nr.:

Solo-Rondomat

Best.Var:  
PCB-Artikelnr.: 000000